

# Topiary

## TOPIARY FORMS

For centuries all the great gardens in Europe have had amazing exhibitions of topiary work. Bushes and closely filled trees were grown and then an expert gardner who was part sculptor would trim these into the shape of balls, pyramids, peacocks, roosters, etc. Some of these figures took generations to grow.

Here, in America, we have invented a better and faster way to enjoy the beauty of topiaries. We had to devise a way to create these topiary forms so that they could be grown quickly and the gardner could use the form as a guide for the proper shape.

The sizes shown for topiary frames are sizes that were chosen arbitrarily. The drawings are approximately to scale, and in most cases we will only give one dimension. As these are custom made, you may change the dimensions to suit your taste and location or you may design your own. Our topiaries are all handmade from heavy gauge stainless steel rods and fastened together into the shape. We will be able to quote immediately on the topiary design, if we are able to manufacture it.



NO. 2405 ENGLISH PEACOCK

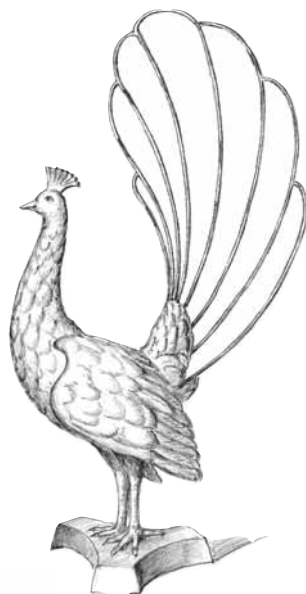

4127 TOPIARY POUTER  
PIGEON

Stainless Steel  
48" h

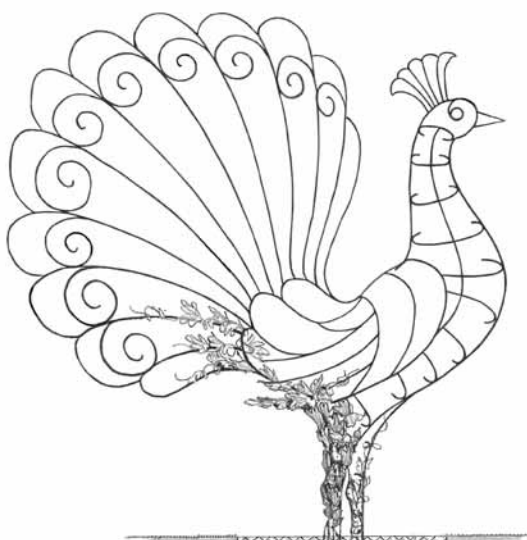
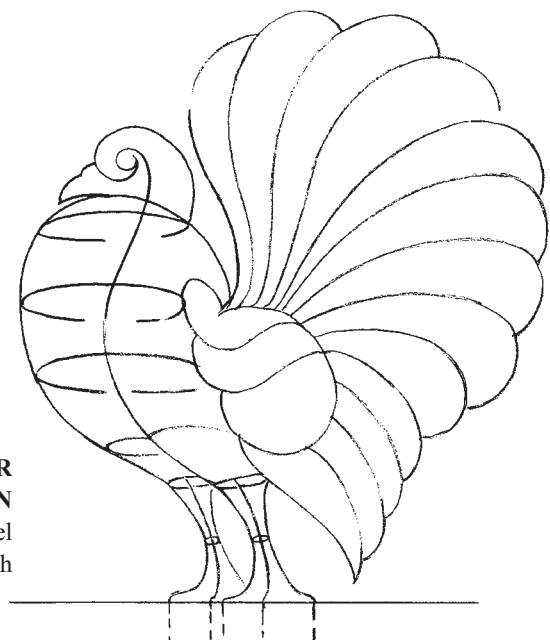

NO. 4161 TOPIARY PEACOCK

Stainless Steel  
48" h

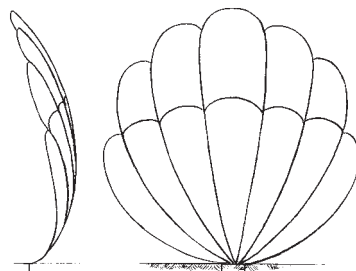

NO. 4197 TOPIARY PEACOCK  
TAIL

Stainless Steel  
36" tall

To be used with our Lead peacocks.

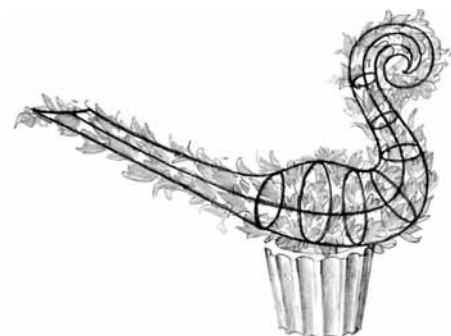

NO. 4624 TOPIARY BIRD

Stainless Steel  
16" h X 32" l



**NO. 4143 TOPIARY POODLE**  
Stainless Steel  
36" l

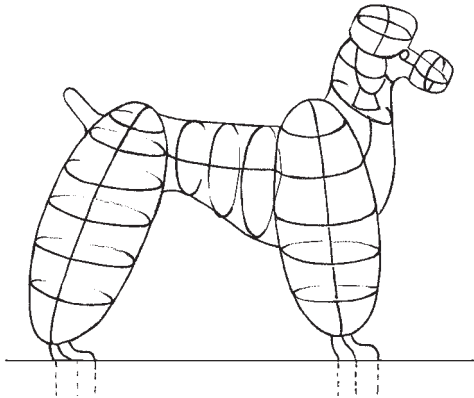

**NO. 4144 TOPIARY POODLE**  
Stainless Steel  
36" l

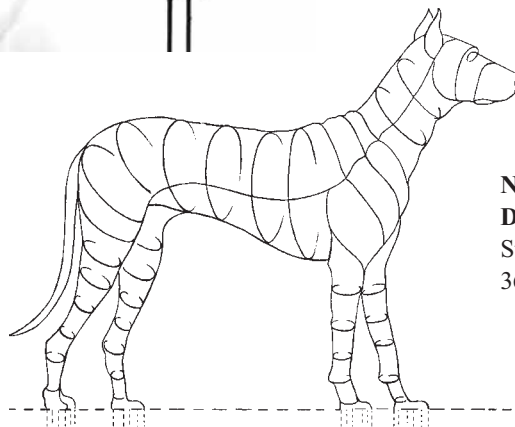

**NO. 4164 TOPIARY DOG**  
Stainless Steel  
36" l

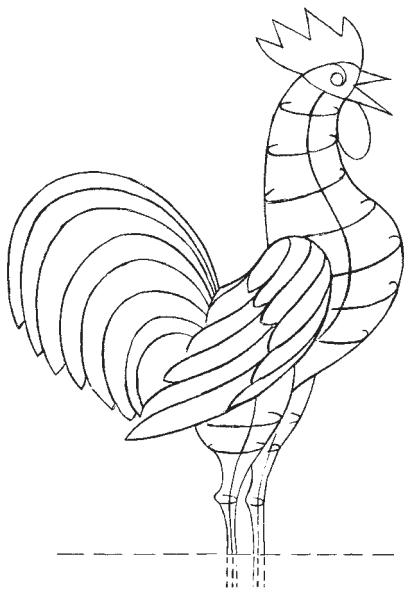

**NO. 4162 TOPIARY ROOSTER**  
Stainless Steel  
48" h

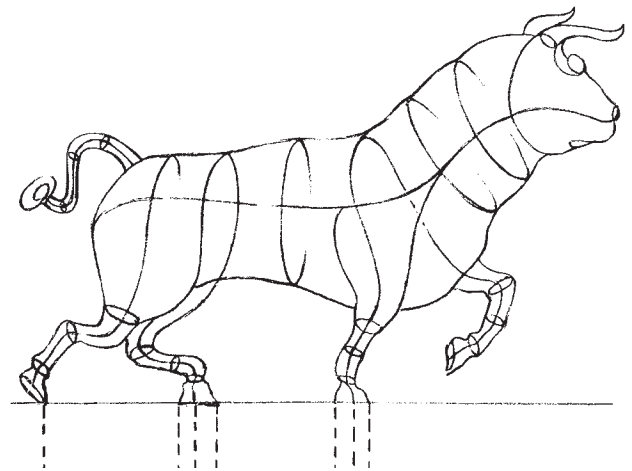

**NO. 4128 TOPIARY BULL**  
Stainless Steel  
72" l

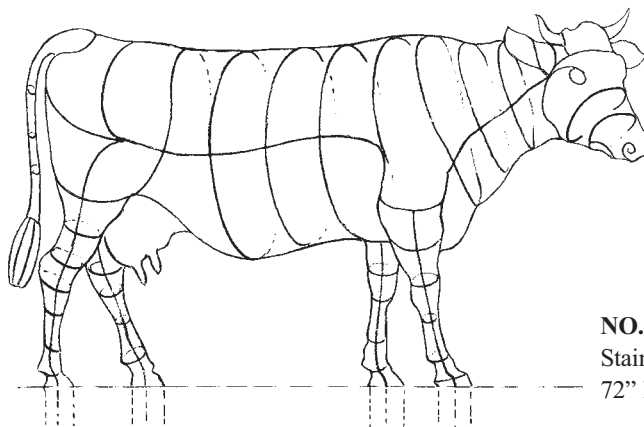

**NO. 4168 TOPIARY COW**  
Stainless Steel  
72" l

# TOPIARIES

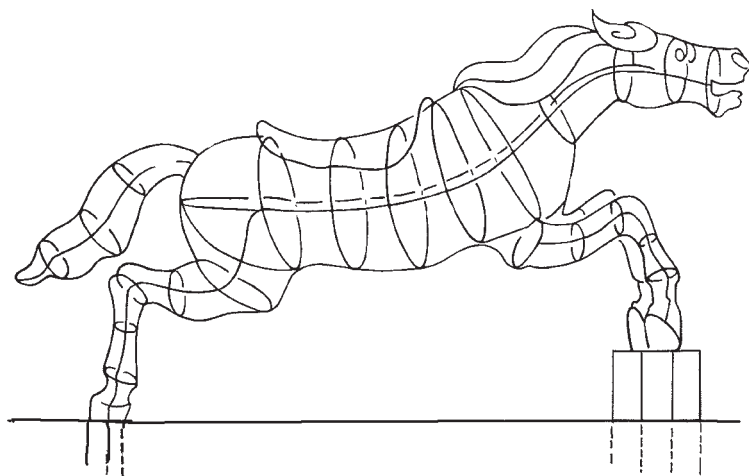

**NO. 4150 TOPIARY  
CAROUSEL HORSE**  
Stainless Steel  
72" 1

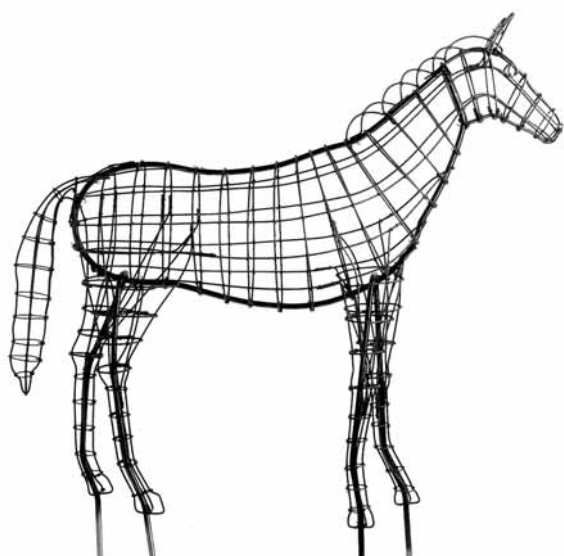

**NO. 4165 TOPIARY HORSE**  
Stainless Steel  
60" 1

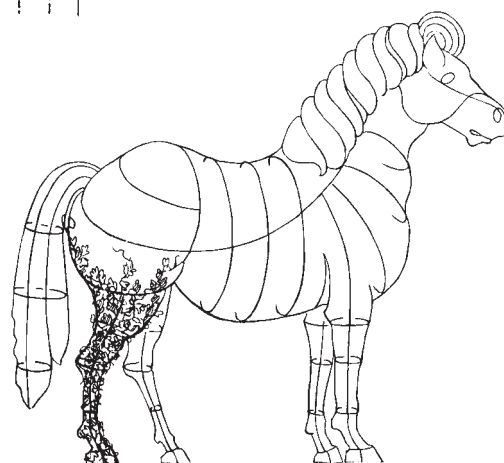

**NO. 4163 TOPIARY PONY**  
Stainless Steel  
48" 1

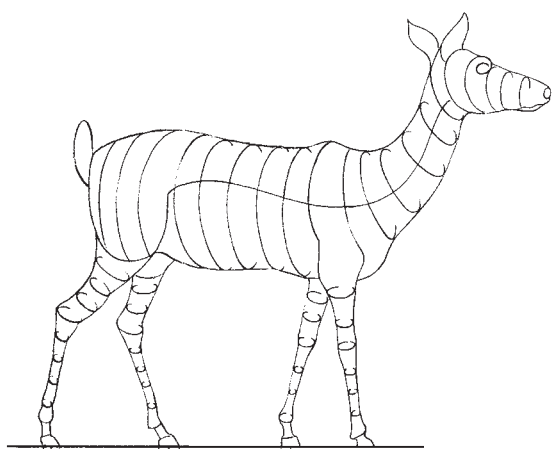

**NO. 4169 TOPIARY DEER**  
Stainless Steel  
60" 1

**NO. 4171 TOPIARY  
DRAFT HORSE**  
Stainless Steel  
60" 1

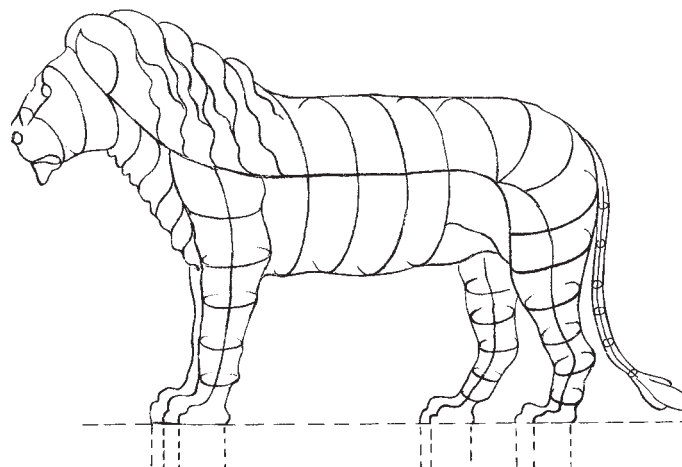
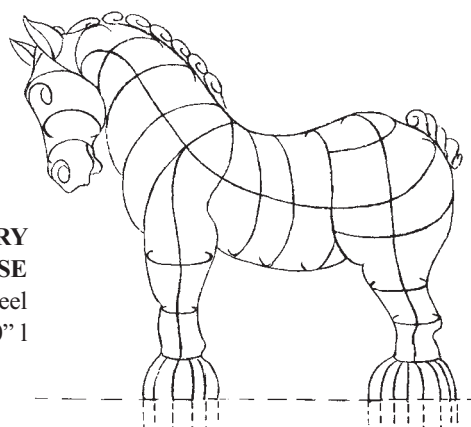

**NO. 4170 TOPIARY LION**  
Stainless Steel  
60" 1

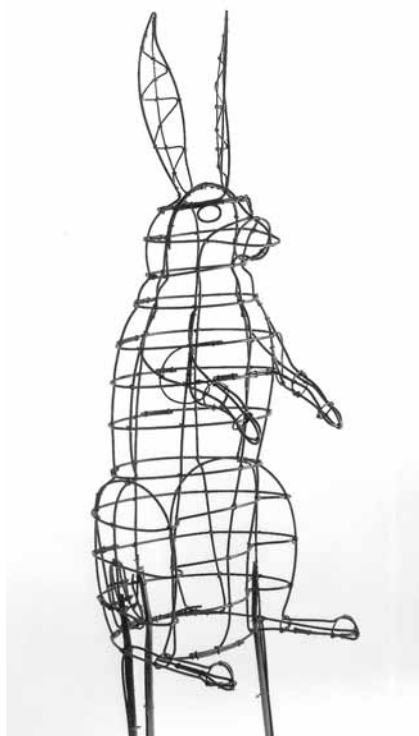

**NO. 4138 TOPIARY RABBIT**  
Stainless Steel  
48" h

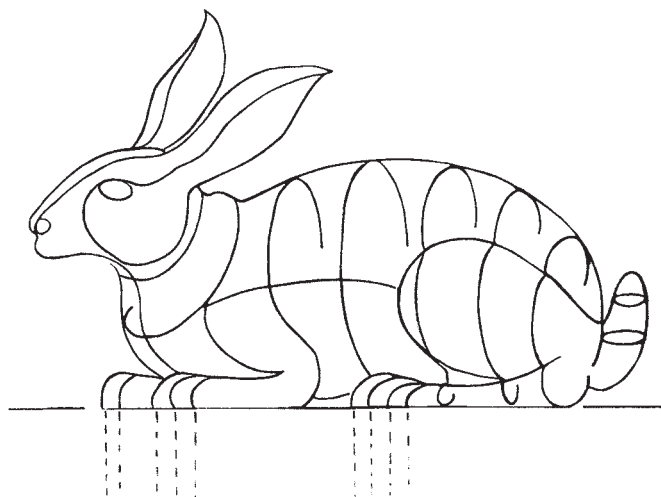

**NO. 4139 TOPIARY RABBIT**  
Stainless Steel  
48" l

**NO. 4167 TOPIARY HIPPO**  
Stainless Steel, 72"l

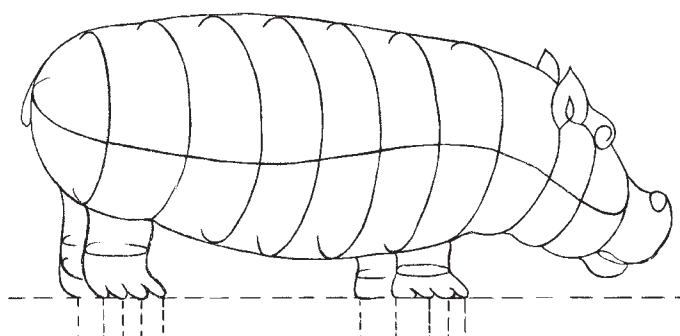

**NO. 4159  
TOPIARY  
GIRAFFE**  
Stainless Steel  
108" h (9 ft.)

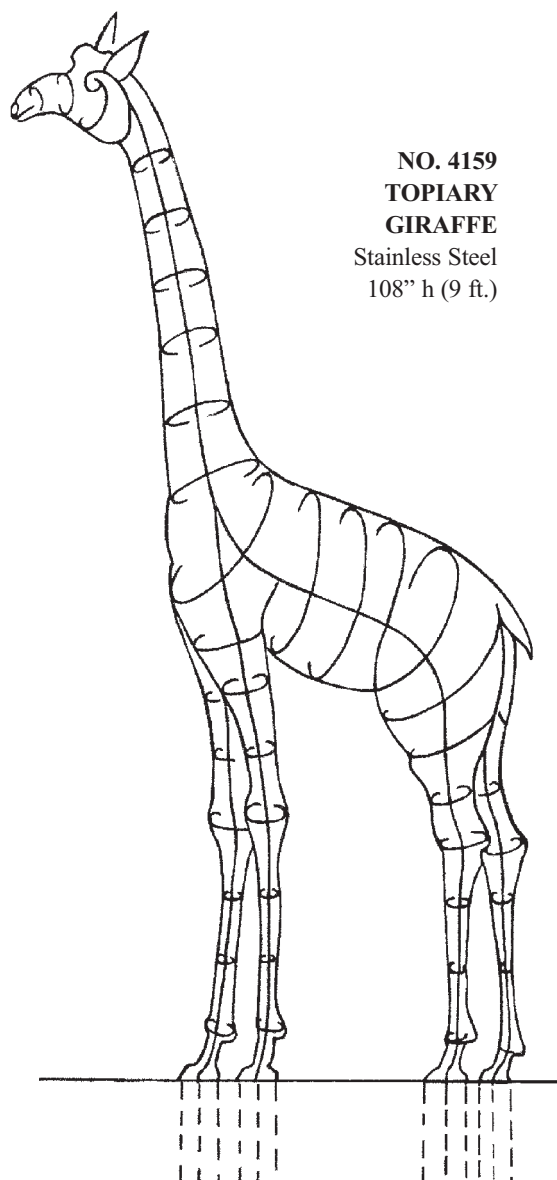

**NO. 4166  
TOPIARY  
ELEPHANT**  
Stainless Steel,  
84"l

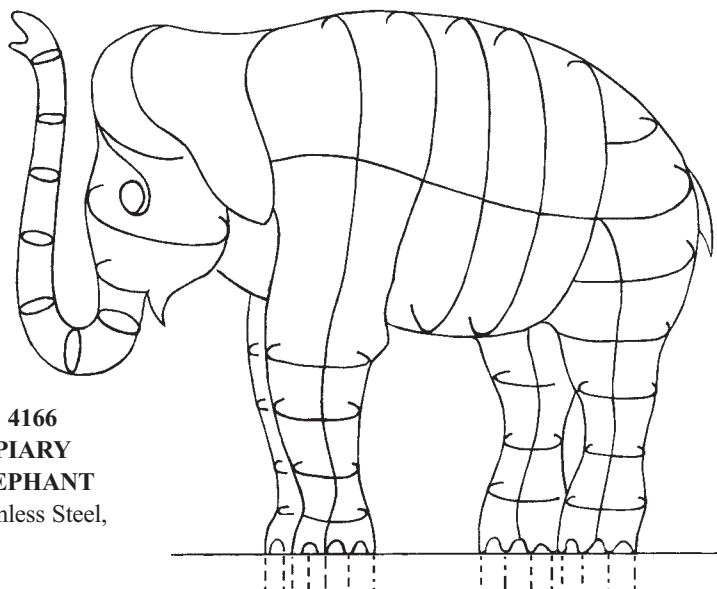

# TOPIARIES

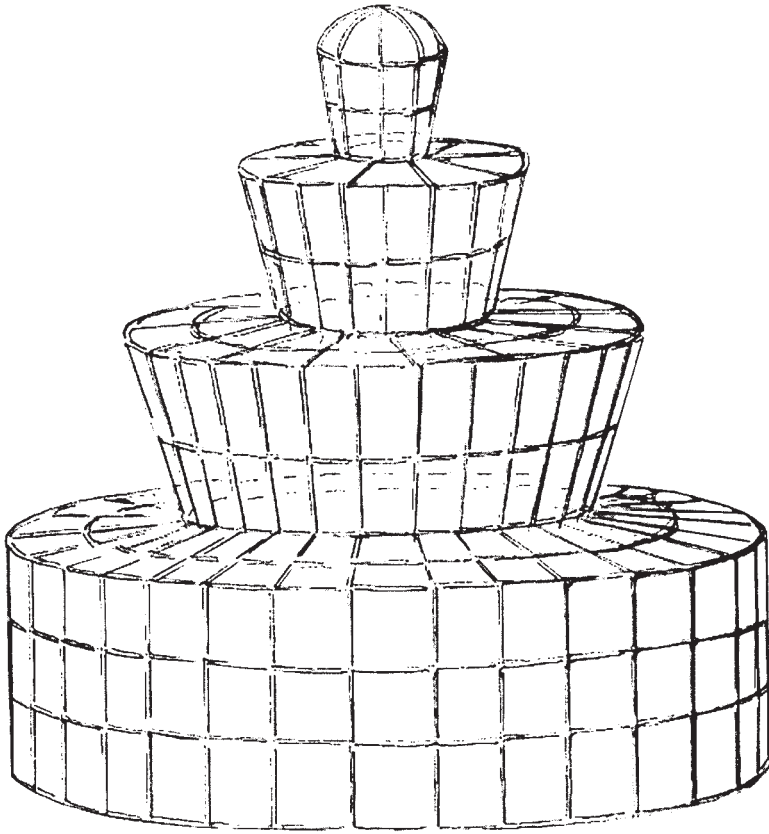

**NO. 4129 TOPIARY ENGLISH FORM**

Stainless Steel  
96" h

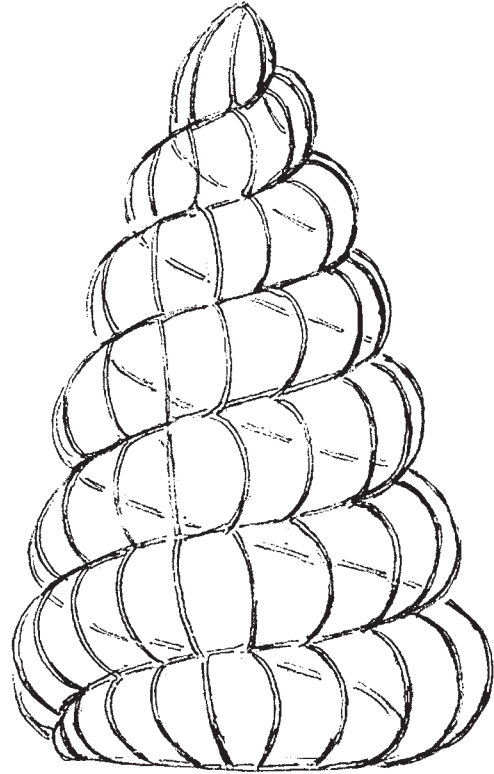

**NO. 4130 TOPIARY FRENCH SPIRAL**

Stainless Steel  
72" h

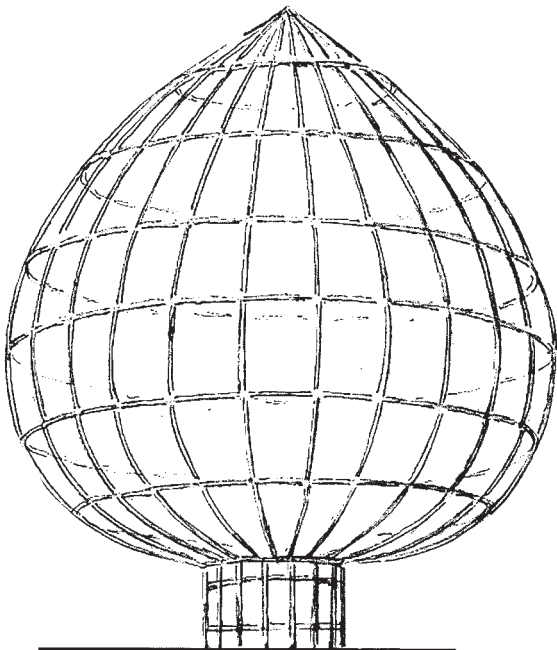

**NO. 4131 TOPIARY DESIGN**

Stainless Steel  
72" h

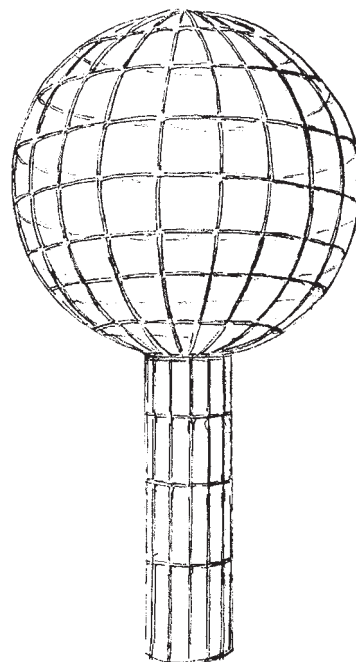

**NO. 4132 TOPIARY DESIGN**

Stainless Steel  
72" h

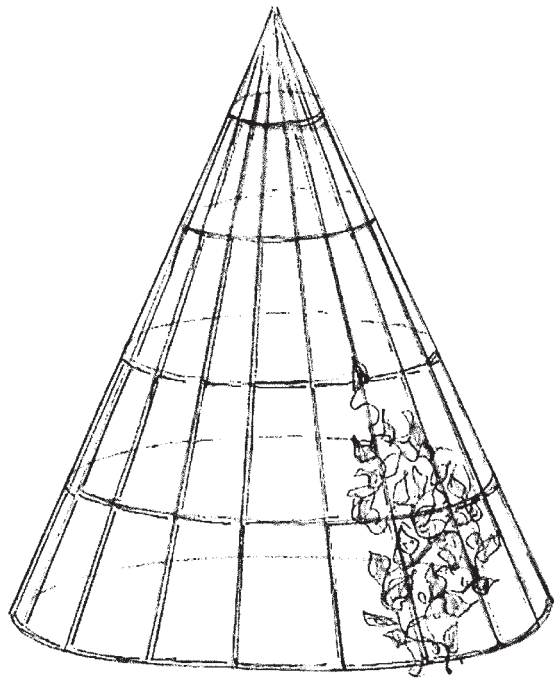

**NO. 4133 TOPIARY CONE**  
Stainless Steel  
72”h

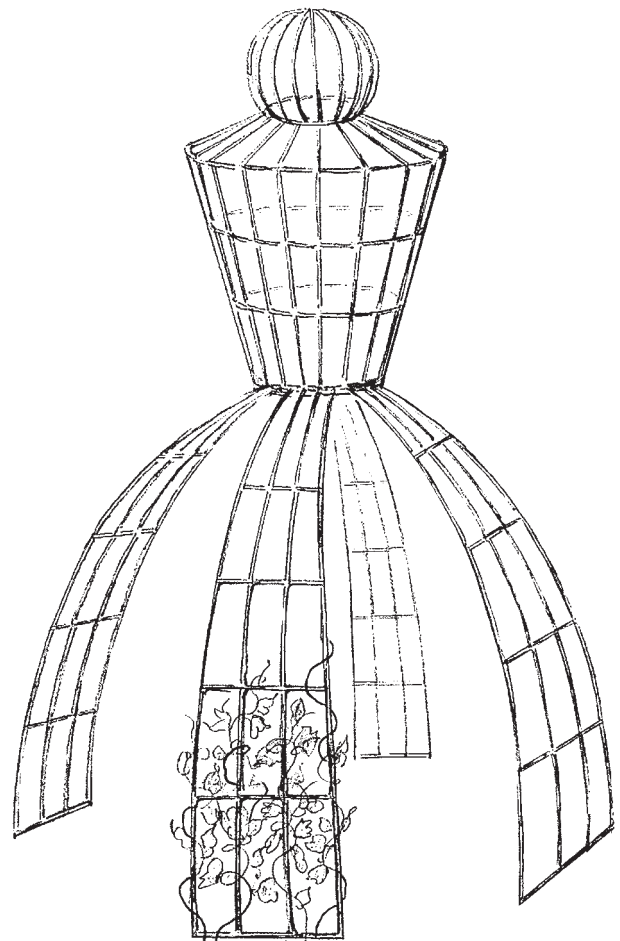

**NO. 4134 TOPIARY BOWER**  
Stainless Steel  
96”h

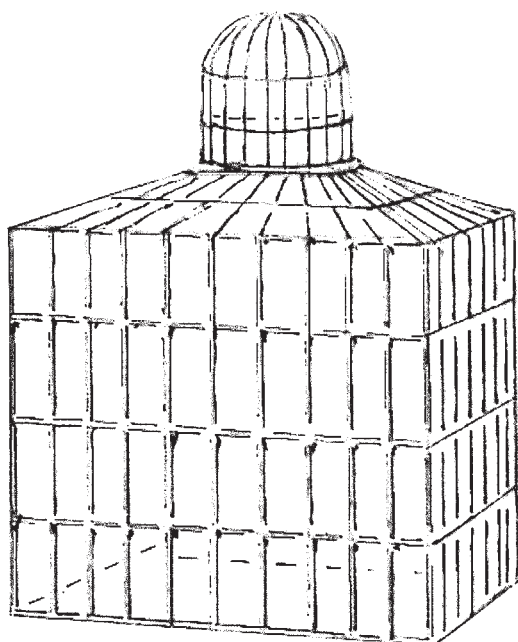

**NO. 4135 TOPIARY DESIGN**  
Stainless Steel  
60”h

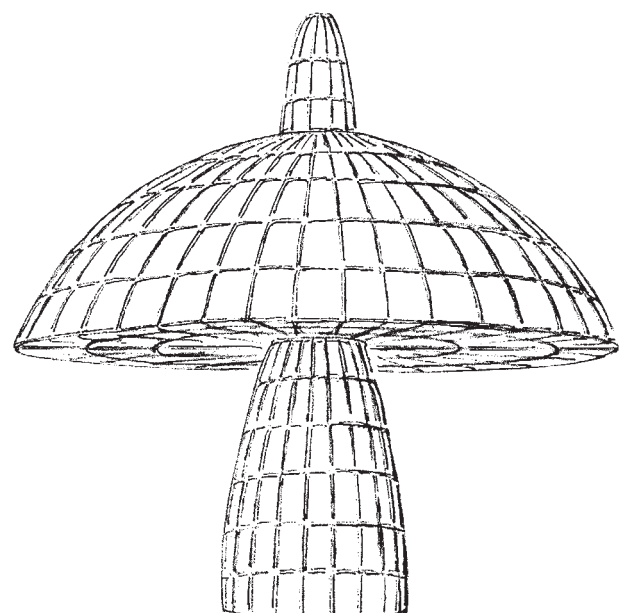

**NO. 4136 TOPIARY MUSHROOM**  
Stainless Steel  
72”h

# TOPIARIES

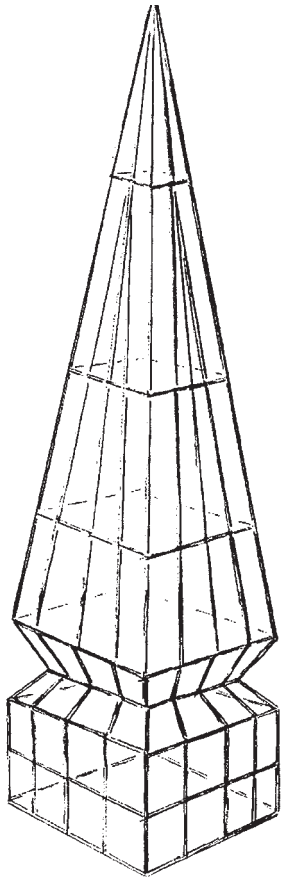

**NO. 4137 TOPIARY OBELISK**  
Stainless Steel  
72”h

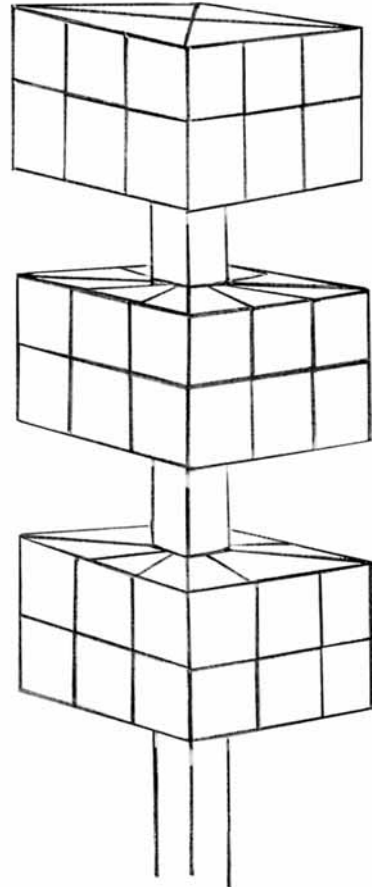

**NO. 4146 TOPIARY BOX DESIGN**  
Stainless Steel  
72”h

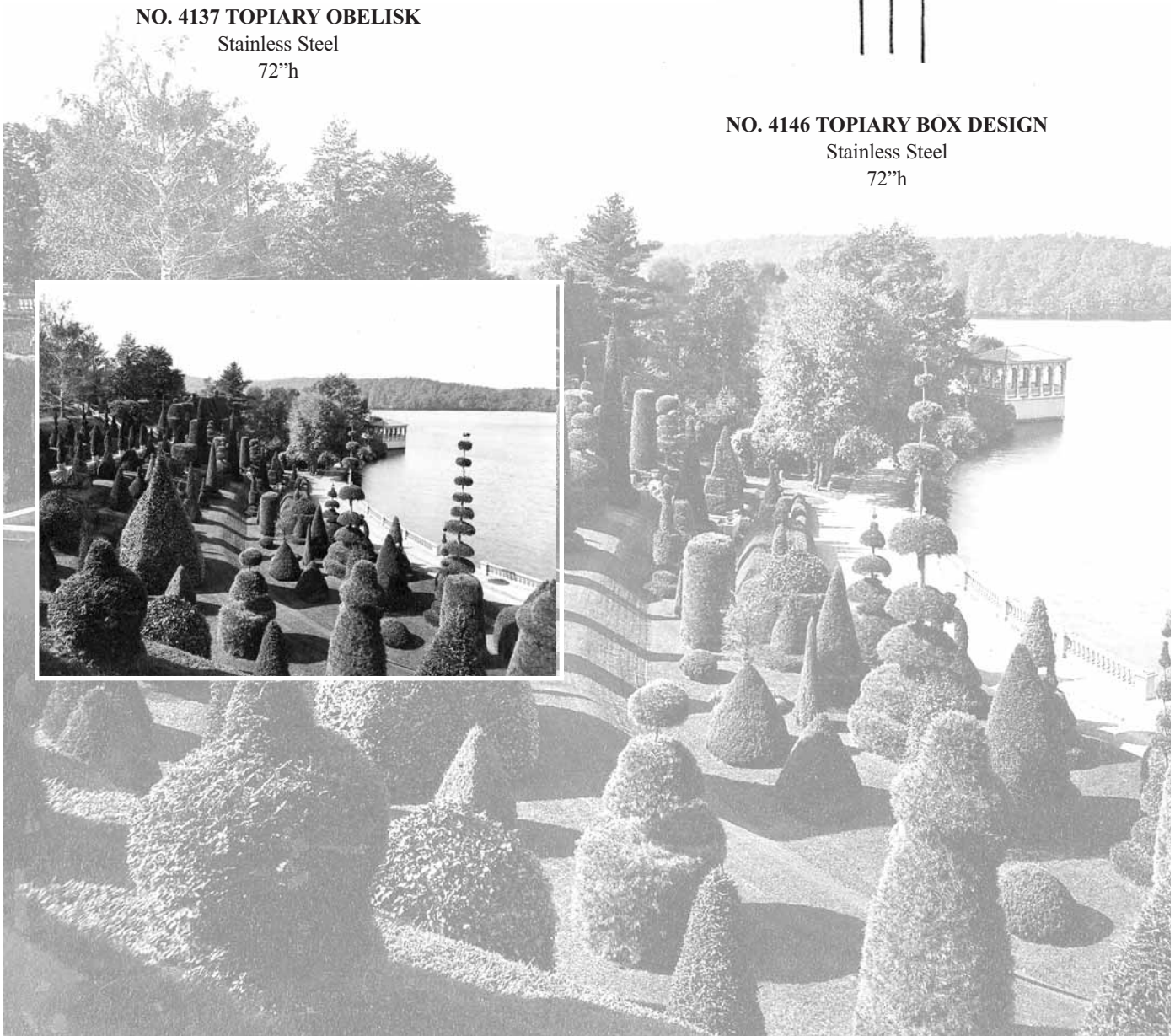





# TOPIARIES

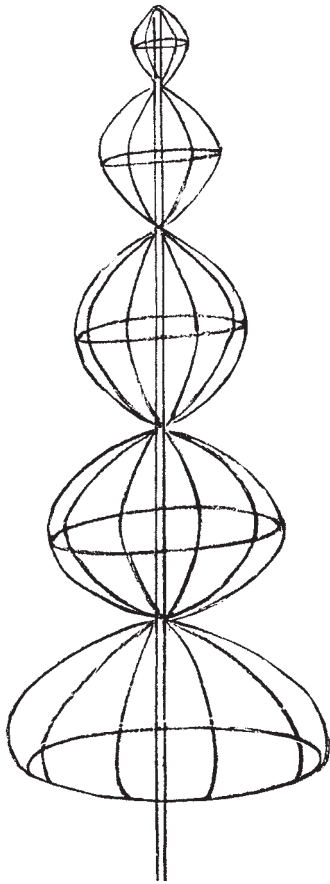

**NO. 4148 TOPIARY DESIGN**  
Stainless Steel  
72" h

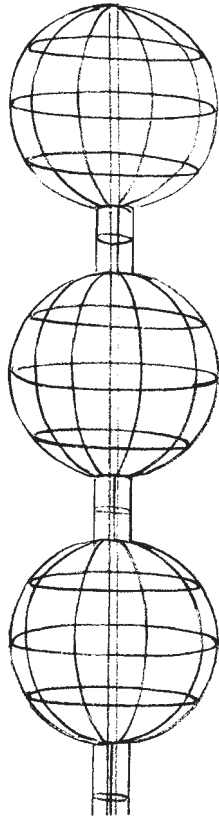

**NO. 4154 TOPIARY DESIGN**  
Stainless Steel  
96" h

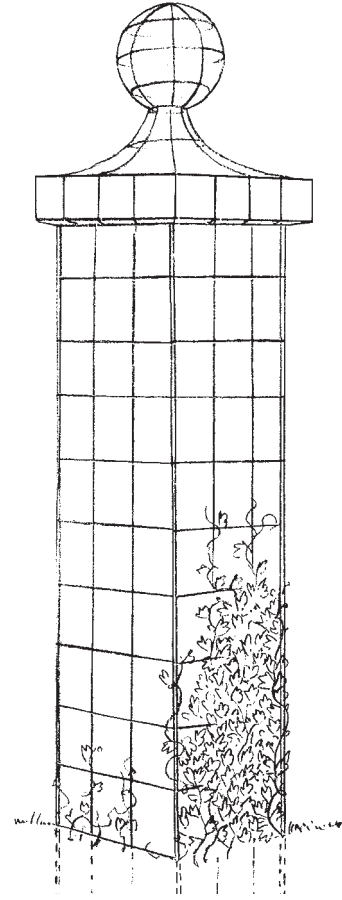

**NO. 4153 TOPIARY GATE POST**  
Stainless Steel  
108" h

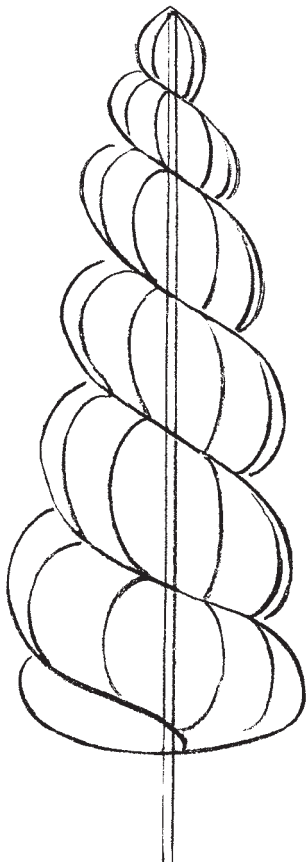

**NO. 4147 TOPIARY SPIRAL**  
Stainless Steel  
72" h

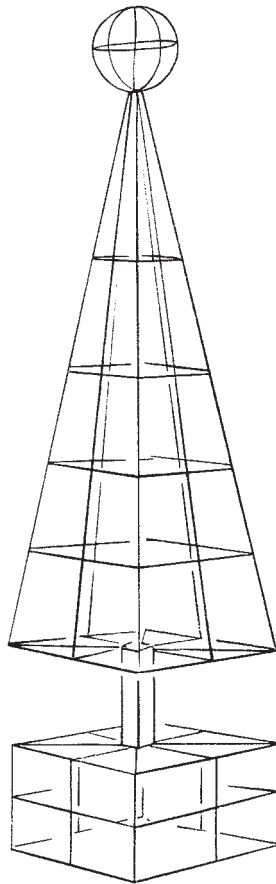

**NO. 4155 TOPIARY  
OBELISK**  
Stainless Steel  
96" h

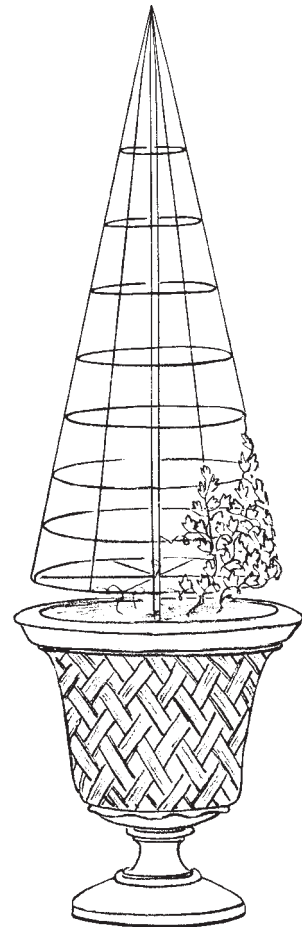

**NO. 4157 TOPIARY CONE DESIGN**  
Stainless Steel  
48" h  
No. 1344 Urn is sold separately.

## TIPS ON ANCHORING TOPIARIES

Most smaller topiaries are made with extensions to the frame for anchoring in the ground. Sometimes these are set into masonry. Very large frames, say for an arbor or pergola, should have proper footings to prevent movement. While we are happy to help with the design of the topiary, we suggest that you employ an architect to design any footings. We are happy to work with your architect.

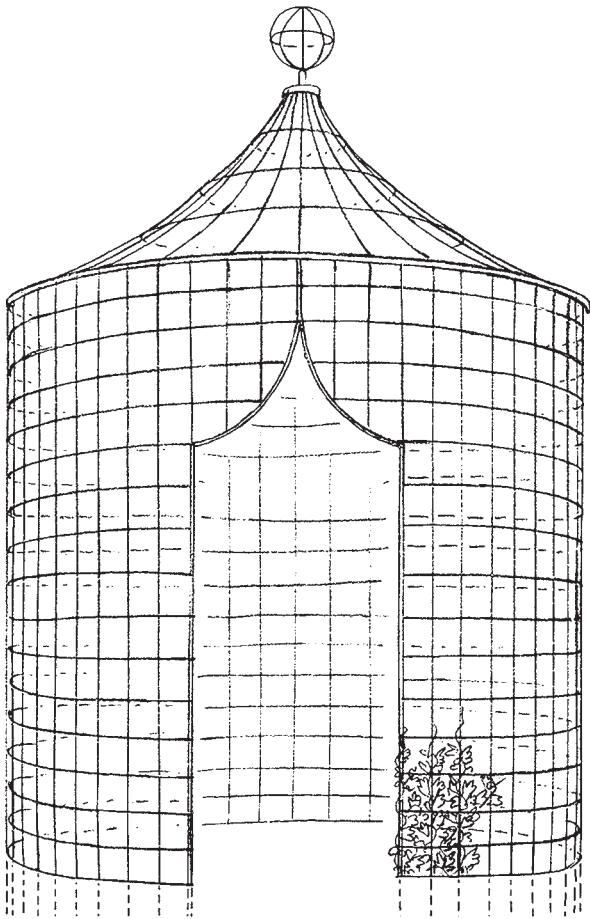

**NO. 4160 TOPIARY GAZEBO**  
Stainless Steel  
120" h (10 ft.)

**NO. 4626 TOPIARY GARDEN HOUSE**  
Stainless Steel  
10'x10'  
Bolts together. Sized to order.

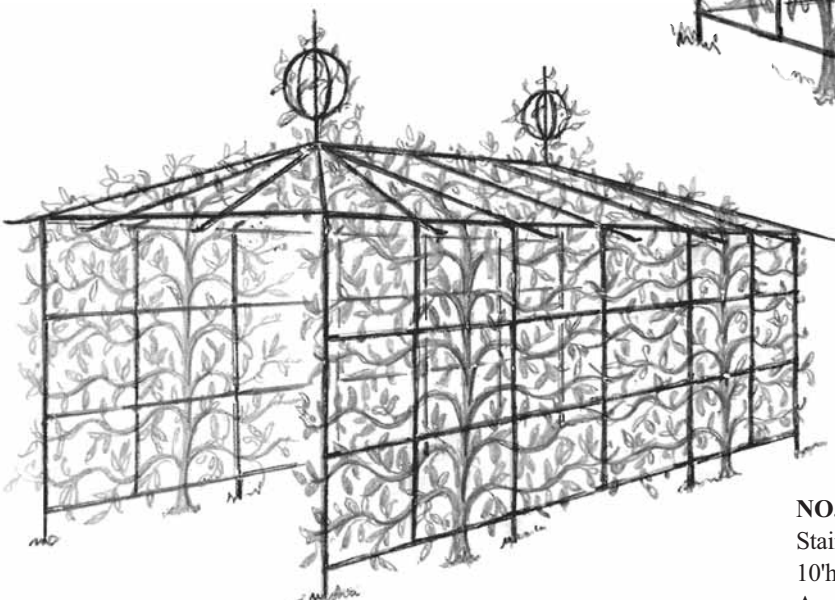
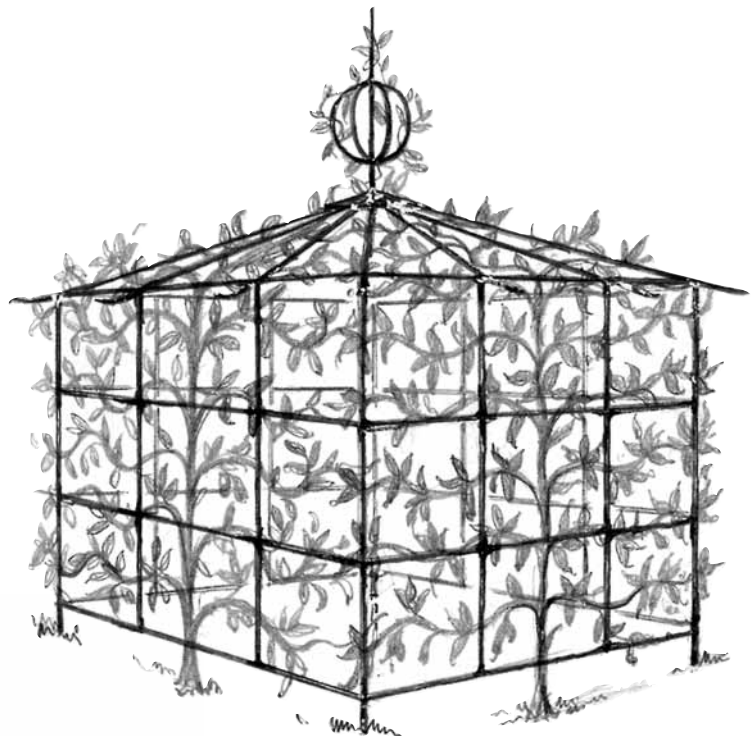

**NO. 4625 TOPIARY GRAPE ARBOR**  
Stainless Steel  
10'h X 20'l  
Available in any length.

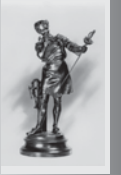

## GARDEN EDGING

There is occasionally a need for edging to separate garden from path or grass. We have seen many different offerings. Here is ours. We suggest that it can be made straight, as corners, in various radii, and in shapes such as pool curbing No. 275. We are suggesting that this edging be made 3' to 6' long, with fiberglass reinforcing, and that only full lengths be made so the installer can cut it in the field to fit the job accurately. Additionally, hose guards and other implements can be installed on this edging as needed. Pieces can be secured end to end below grade to keep them from shifting. It is intended that at a minimum 6" of this edging be buried (in the case that you might be making a step) and that, typically, 9" to 10" will be buried.

### No. 1787 GARDEN EDGING

Cast Stone, 12" H, 3" Thick  
Various lengths and shapes

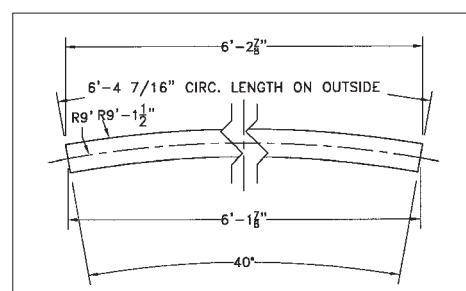
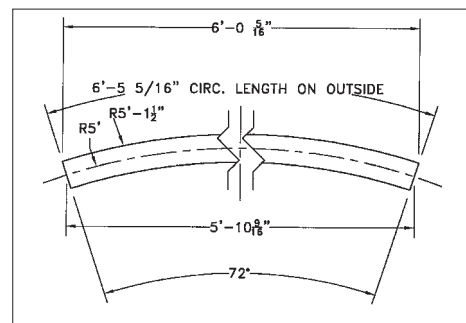
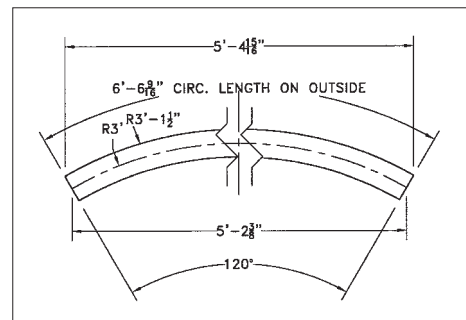
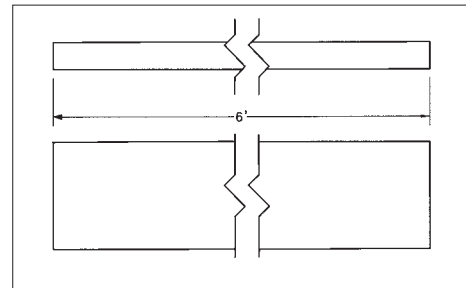
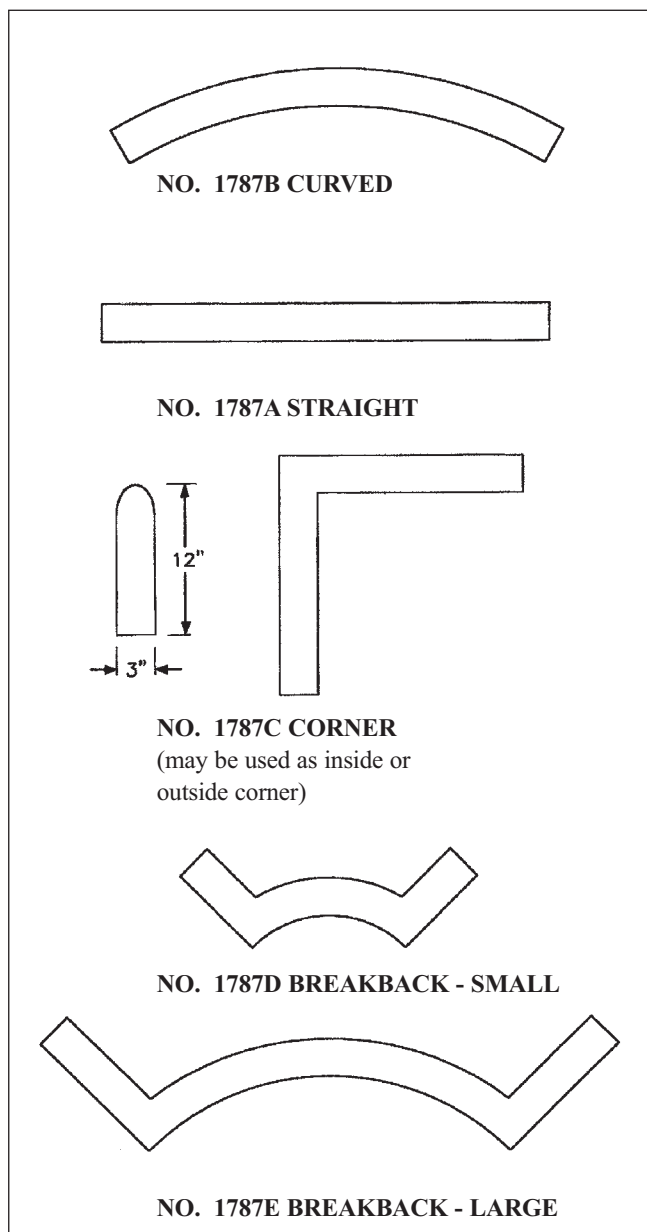

EXISTING MOLDS

# Garden Edging